

Robot Programming with Lisp

6. Search Algorithms

Arthur Niedzwiecki
(G. Kazhoyan,
S. Russell, P. Norvig)

Institute for Artificial Intelligence
University of Bremen

December 15th, 2022

Contents

Problem Definition

Uninformed search strategies

BFS

Uniform-Cost

DFS

Depth-Limited

Iterative Deepening

Informed Search

Greedy

A*

Heuristics

Hill-climbing aka gradient ascent/descent

Simulated annealing

Organizational

Problem Definition

Uninformed search strategies

Informed Search

Organizational

Problem types

Deterministic, fully observable \implies *single-state problem*

Agent knows exactly which state it will be in.

Solution is a sequence of actions

Deterministic, non-observable \implies *conformant problem*

Agent may have no idea where it is.

Solution (if any) is a sequence of actions

Nondeterministic, partially observable \implies *contingency problem*

must perceive the world during execution

solution is a contingent plan or a policy

often replan during execution

Unknown state space \implies *exploration problem* (“online”)

Example: vacuum world

Single-state, start in #5.

Solution? [Right, Vacuum]

Conformant, start in $\{1, 2, 3, 4, 5, 6, 7, 8\}$

e.g., *Right* goes to $\{2, 4, 6, 8\}$.

Solution? [Right, Vacuum, Left, Vacuum]

Contingency, start in #5

Vacuum can dirty a clean carpet.

Local sensing only at current location.

Solution? [Right, if dirt then Vacuum]

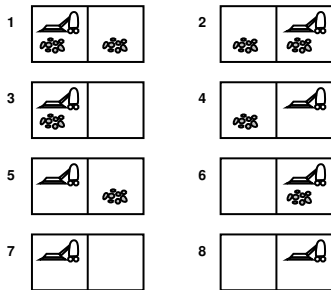

Single-state problem formulation

A *problem* is defined by four items:

- *initial state*
- *operators* (or *successor function* $S(x)$)
e.g., $\text{Vacuum}(x) \rightarrow \text{clean room}$
- *goal test*
- *path cost* (additive)
e.g., sum of distances, number of operators executed, etc.

A *solution* is a sequence of operators leading from the initial state to a goal state

Example: The 8-puzzle

5	4	
6	1	8
7	3	2

Start State

1	2	3
8		4
7	6	5

Goal State

states ?

operators ?

goal test ?

path cost ?

Example: The 8-puzzle

5	4	
6	1	8
7	3	2

Start State

1	2	3
8		4
7	6	5

Goal State

states: integer locations of tiles (ignore intermediate positions)

operators: ?

goal test: ?

path cost: ?

Example: The 8-puzzle

5	4	
6	1	8
7	3	2

Start State

1	2	3
8		4
7	6	5

Goal State

states: integer locations of tiles (ignore intermediate positions)

operators: move blank left, right, up, down (ignore unjamming etc.)

goal test: ?

path cost: ?

Example: The 8-puzzle

5	4	
6	1	8
7	3	2

Start State

1	2	3
8		4
7	6	5

Goal State

states: integer locations of tiles (ignore intermediate positions)

operators: move blank left, right, up, down (ignore unjamming etc.)

goal test: current state = goal state

path cost: ?

Example: The 8-puzzle

5	4	
6	1	8
7	3	2

Start State

1	2	3
8		4
7	6	5

Goal State

states: integer locations of tiles (ignore intermediate positions)

operators: move blank left, right, up, down (ignore unjamming etc.)

goal test: current state = goal state

path cost: 1 per move

Example: vacuum world state space graph

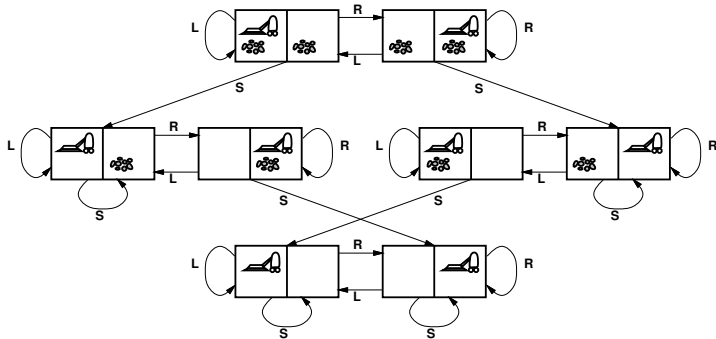

states ?

operators ?

goal test ?

path cost ?

Problem Definition

Uninformed search strategies

Informed Search

Organizational

Example: vacuum world state space graph

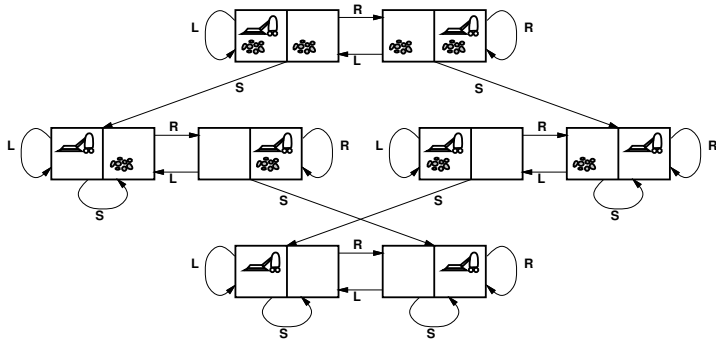

states: integer dirt and robot locations (ignore dirt *amounts*)

operators: ?

goal test: ?

path cost: ?

Example: vacuum world state space graph

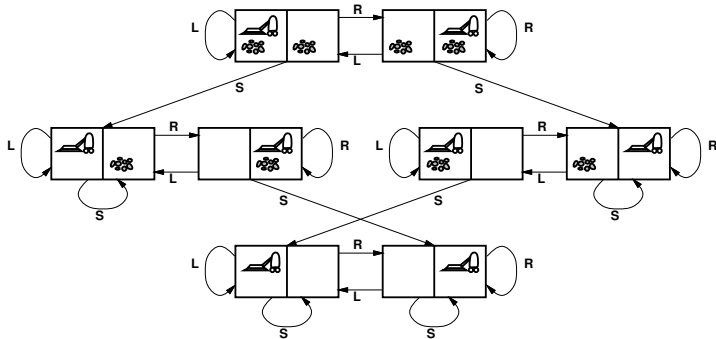

states: integer dirt and robot locations (ignore dirt *amounts*)

operators: *Left, Right, Vacuum*

goal test: ?

path cost: ?

Example: vacuum world state space graph

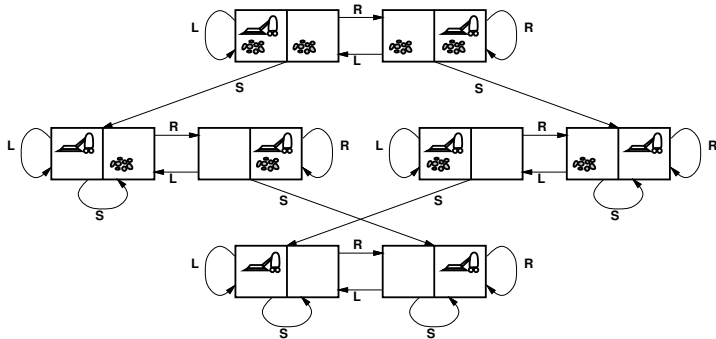

states: integer dirt and robot locations (ignore dirt *amounts*)

operators: *Left, Right, Vacuum*

goal test: no dirt in current state

path cost: ?

Example: vacuum world state space graph

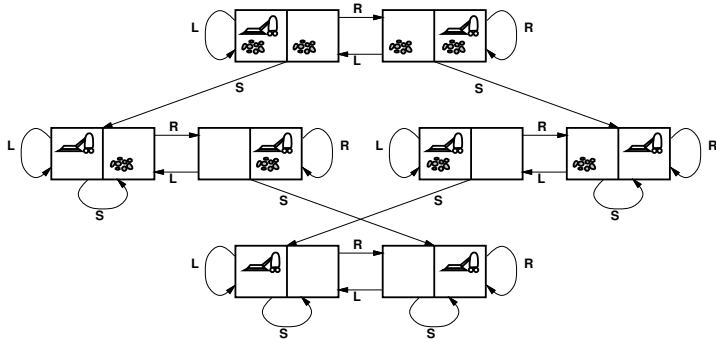

states: integer dirt and robot locations (ignore dirt *amounts*)

operators: *Left, Right, Vacuum*

goal test: no dirt in current state

path cost: 1 per operator

Example: robotic assembly

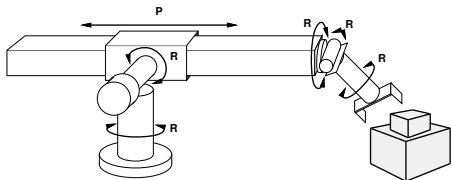

states ?

operators ?

goal test ?

path cost ?

Example: robotic assembly

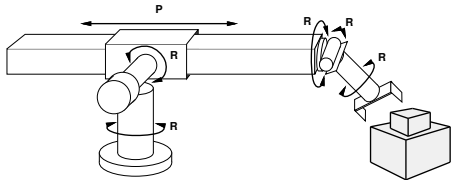

states: real-valued coordinates of robot joint angles and parts of the object to be assembled

operators: ?

goal test: ?

path cost: ?

Example: robotic assembly

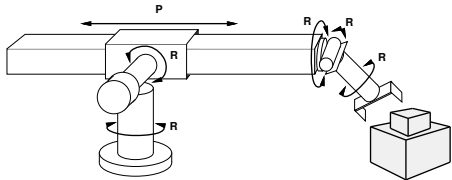

states: real-valued coordinates of robot joint angles and parts of the object to be assembled

operators: continuous motions of robot joints

goal test: ?

path cost: ?

Example: robotic assembly

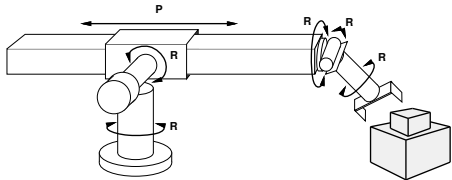

states: real-valued coordinates of robot joint angles and parts of the object to be assembled

operators: continuous motions of robot joints

goal test: assembly object is complete

path cost: ?

Example: robotic assembly

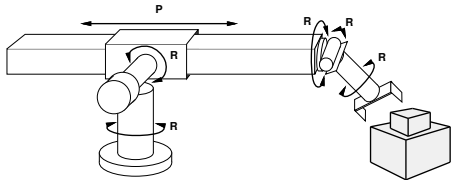

states: real-valued coordinates of robot joint angles and parts of the object to be assembled

operators: continuous motions of robot joints

goal test: assembly object is complete

path cost: time to execute

Search algorithms

Basic idea:

offline, simulated exploration of state space
by generating successors of already-explored states
(a.k.a. *expanding* states)

```
function General-Search(problem, strategy) returns a solution, or failure
  initialize the search tree using the initial state of problem
  loop do
    if there are no candidates for expansion then return failure
    choose a leaf node for expansion according to strategy
    if the node contains a goal state then return corresponding solution
    else expand the node and add the resulting nodes to the search tree
  end
```

General search example

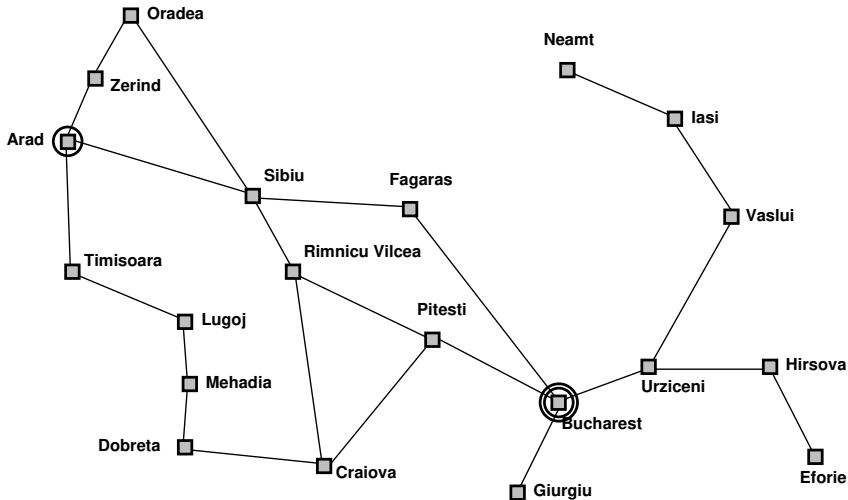

Problem Definition

Uninformed search strategies

Informed Search

Organizational

General search example

Arad

General search example

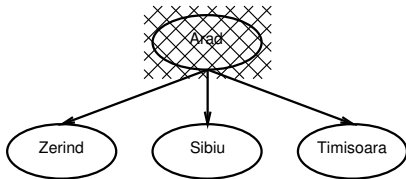

General search example

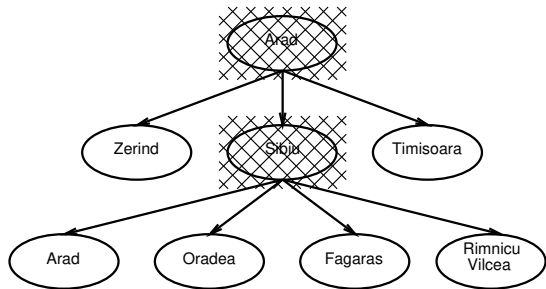

General search example

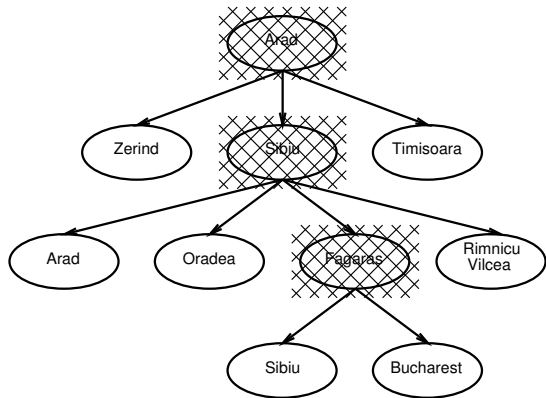

Implementation of search algorithms

```
function General-Search( problem, Queuing-Fn) returns a solution, or failure
  nodes ← Make-Queue(Make-Node(Initial-State[problem]))
  loop do
    if nodes is empty then return failure
    node ← Remove-Front(nodes)
    if Goal-Test[problem] applied to State(node) succeeds then return
  node
  nodes ← Queuing-Fn(nodes, Expand(node, Operators[problem]))
end
```

Implementation contd: states vs. nodes

A *state* is a (representation of) a physical configuration

A *node* is a data structure constituting part of a search tree

includes *parent*, *children*, *depth*, *path cost* $g(x)$

States do not have parents, children, depth, or path cost!

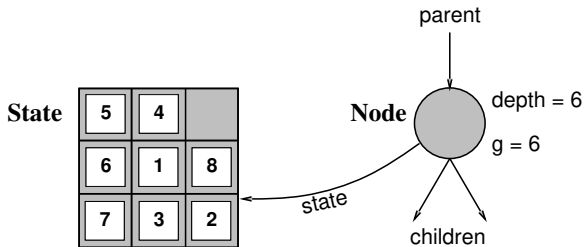

The Expand function creates new nodes, filling in the various fields and using the Operators (or SuccessorFn) of the problem to create the corresponding states.

Search strategies

A strategy is defined by picking the *order of node expansion*

Strategies are evaluated along the following dimensions:

- **completeness**—does it always find a solution if one exists?
- **time complexity**—number of nodes generated/expanded
- **space complexity**—maximum number of nodes in memory
- **optimality**—does it always find a least-cost solution?

Time and space complexity are measured in terms of

- b — maximum branching factor of the search tree
- d — depth of the least-cost solution
- m — maximum depth of the state space (may be ∞)

Contents

Problem Definition

Uninformed search strategies

BFS

Uniform-Cost

DFS

Depth-Limited

Iterative Deepening

Informed Search

Greedy

A*

Heuristics

Hill-climbing aka gradient ascent/descent

Simulated annealing

Organizational

Problem Definition

Uninformed search strategies

Informed Search

Organizational

Uninformed search strategies

Uninformed strategies use only the information available in the problem definition

Uninformed search strategies are:

- Breadth-first search
- Uniform-cost search
- Depth-first search
- Depth-limited search
- Iterative deepening search

Breadth-first search

Expand shallowest unexpanded node

Implementation:

QueueingFn = put successors at end of queue (FIFO queue)



Arad

Breadth-first search

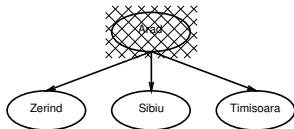

Breadth-first search

- .
- .
- .

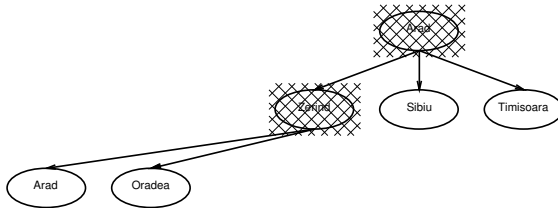

Breadth-first search

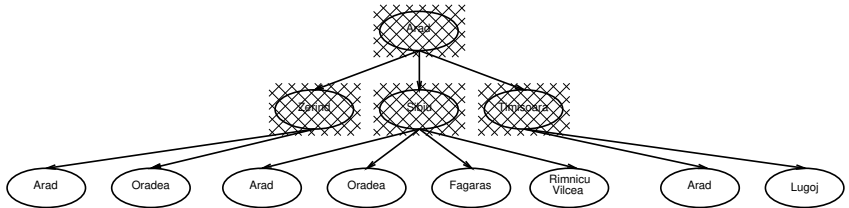

Properties of breadth-first search

Complete ?

Time ?

Space ?

Optimal ?

Properties of breadth-first search

Complete: Yes

Time: $1 + b + b^2 + b^3 + \dots + b^d = O(b^d)$, i.e., exponential in d

Space: $O(b^d)$ (keeps every node in memory)

Optimal: Yes (if cost = 1 per step); not optimal in general

Space is the big problem; can easily generate nodes at N MB/sec.

Romania with step costs in km

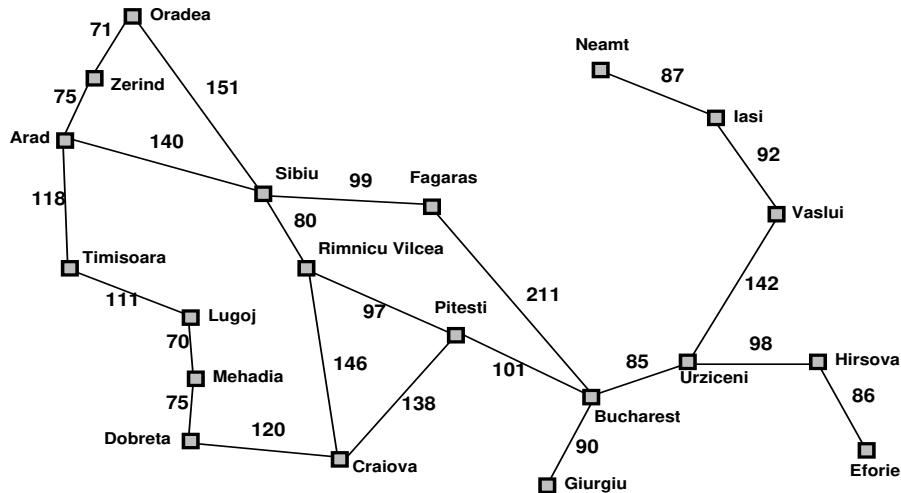

Problem Definition

Uninformed search strategies

Informed Search

Organizational

Uniform-cost search

Expand least-cost unexpanded node

Implementation:

QueueingFn = insert in order of increasing path cost (FIFO queue)



Arad

Uniform-cost search

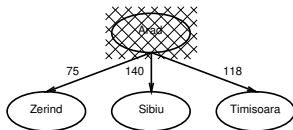

Uniform-cost search

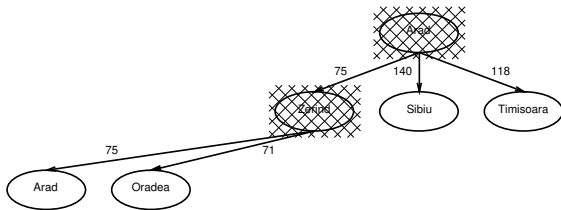

Uniform-cost search

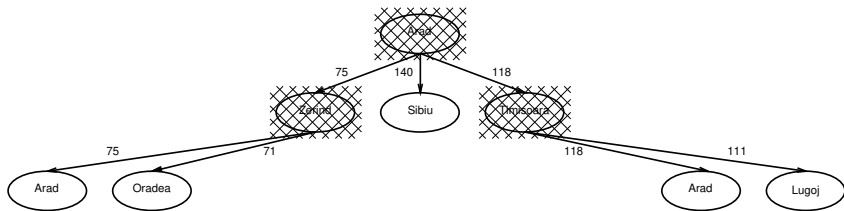

Properties of uniform-cost search

Complete ?

Time ?

Space ?

Optimal ?

Properties of uniform-cost search

Complete: Yes, if step cost $\geq \epsilon$

Time: # of nodes with $g \leq$ cost of optimal solution

Space: # of nodes with $g \leq$ cost of optimal solution

Optimal: Yes

$g(n)$ is the cost of the path up to node n .

Depth-first search

Expand deepest unexpanded node

Implementation:

QueueingFn = insert successors at front of queue (LIFO)



Depth-first search

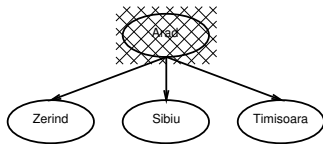

Depth-first search

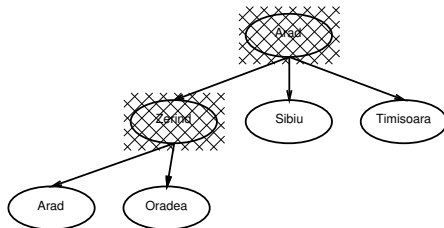

Depth-first search

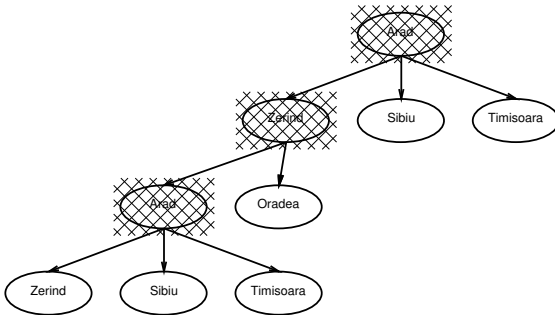

I.e., depth-first search can perform infinite cyclic excursions.

Need a finite, non-cyclic search space (or repeated-state checking).

Problem Definition

Uninformed search strategies

Informed Search

Organizational

DFS on a depth-3 binary tree



DFS on a depth-3 binary tree

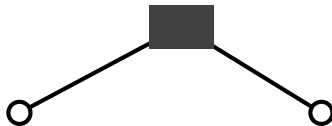

DFS on a depth-3 binary tree

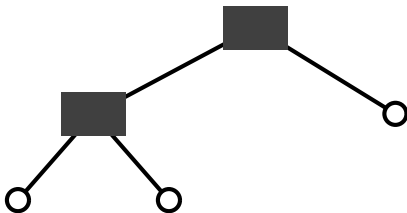

DFS on a depth-3 binary tree

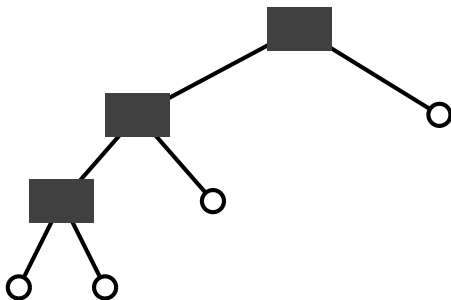

DFS on a depth-3 binary tree

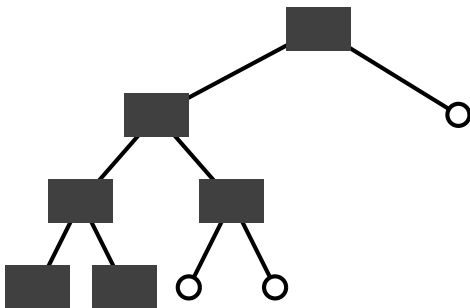

DFS on a depth-3 binary tree, contd.

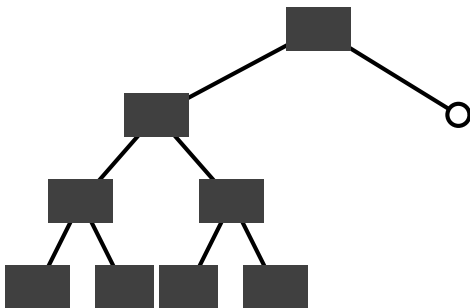

DFS on a depth-3 binary tree

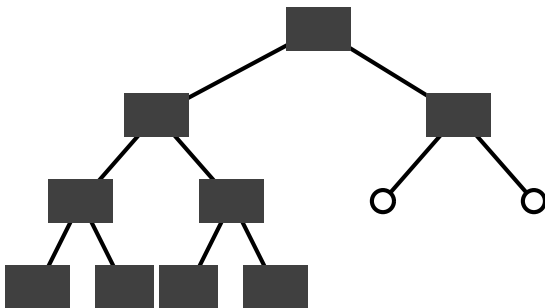

Properties of depth-first search

Complete ?

Time ?

Space ?

Optimal ?

Properties of depth-first search

Complete: No: fails in infinite-depth spaces, spaces with loops
⇒ modify to avoid repeated states along path.

Complete in finite spaces

Time: $O(b^m)$: terrible if m is much larger than d
but if solutions are dense, may be much faster than breadth-first

Space: $O(bm)$, i.e., linear space!

Optimal: No

Depth-limited search

Depth-limited search = depth-first search with depth limit L

Implementation:

Nodes at depth L have no successors

Iterative deepening search

```
function Iterative-Deepening-Search(problem) returns a solution sequence
  inputs: problem, a problem

  for depth  $\leftarrow$  0 to  $\infty$  do
    result  $\leftarrow$  Depth-Limited-Search(problem, depth)
    if result  $\neq$  cutoff then return result
  end
```

Iterative deepening search $L = 0$



Arad

Iterative deepening search $L = 1$



Arad

Iterative deepening search $L = 1$

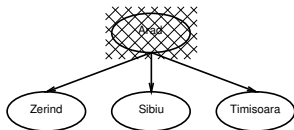

Iterative deepening search $L = 2$



Iterative deepening search $L = 2$

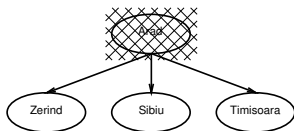

Iterative deepening search $L = 2$

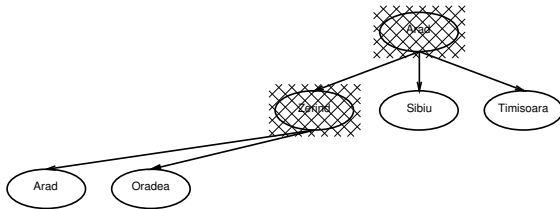

Iterative deepening search $L = 2$

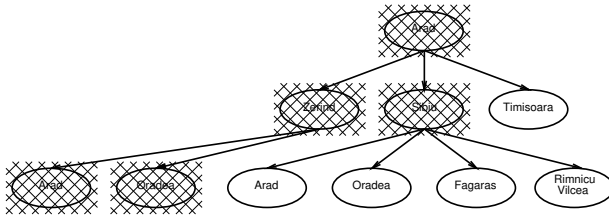

Iterative deepening search $L = 2$

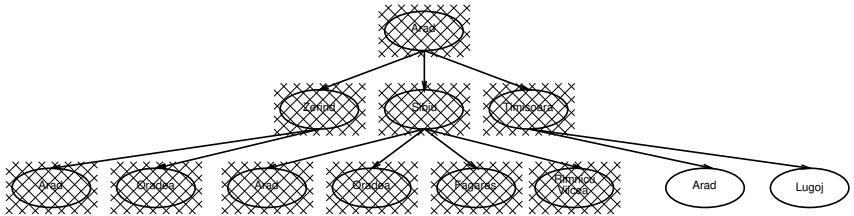

Properties of iterative deepening search

Complete ?

Time ?

Space ?

Optimal ?

Properties of iterative deepening search

Complete: Yes

Time: $(d + 1)b^0 + db^1 + (d - 1)b^2 + \dots + b^d = O(b^d)$

Space: $O(bd)$

Optimal: Yes, if step cost = 1

Can be modified to explore uniform-cost tree.

Iterative deepening search uses only linear space
and not much more time than other uninformed algorithms

Contents

Problem Definition

Uninformed search strategies

BFS

Uniform-Cost

DFS

Depth-Limited

Iterative Deepening

Informed Search

Greedy

A*

Heuristics

Hill-climbing aka gradient ascent/descent

Simulated annealing

Organizational

Problem Definition

Uninformed search strategies

Informed Search

Organizational

Informed search

Idea: use an *evaluation function* for each node as an estimate of “desirability”

⇒ Expand most desirable unexpanded node

Implementation:

QueueingFn = insert successors in decreasing order of desirability

Romania with straight line distances in km

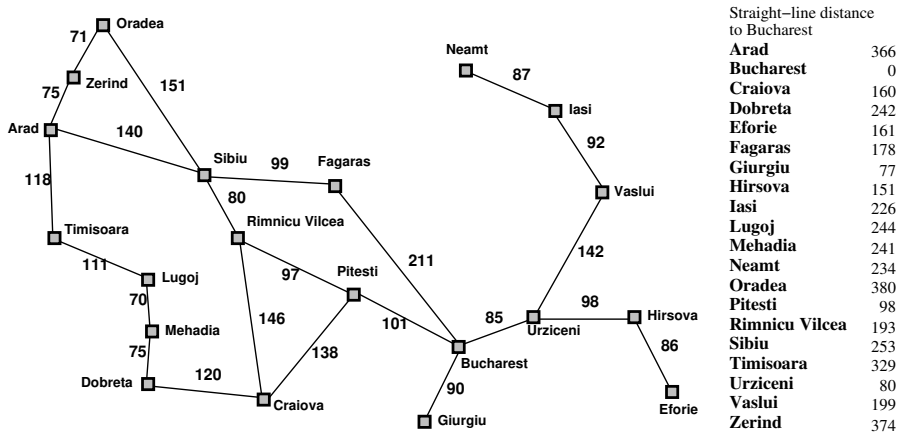

Problem Definition

Uninformed search strategies

Informed Search

Organizational

Greedy search

Evaluation function $h(n)$ (**h**euristic)
= estimate of cost from n to *goal*

E.g., $h_{\text{SLD}}(n)$ = straight-line distance from n to Bucharest

Greedy search expands the node that *appears* to be closest to goal

Greedy search example

Arad
366

Greedy search example [2]

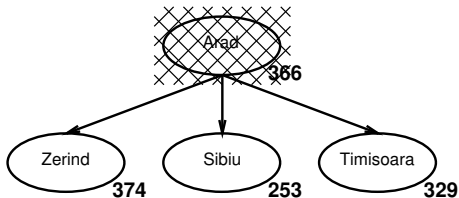

Greedy search example [3]

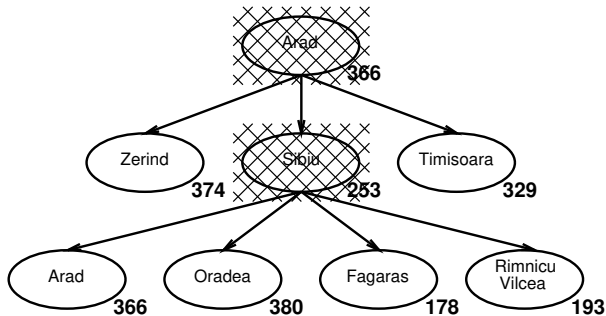

Greedy search example [4]

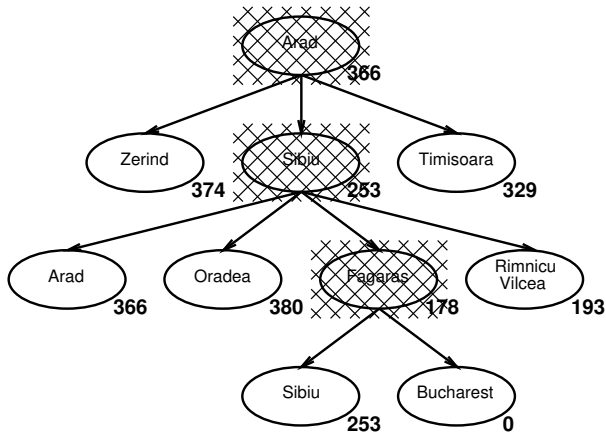

Problem Definition

Uninformed search strategies

Informed Search

Organizational

Properties of greedy search

Complete ?

Time ?

Space ?

Optimal ?

Properties of greedy search

Complete: No – can get stuck in loops, e.g.,

lasi → Neamt → lasi → Neamt → ...

Complete in finite space with repeated-state checking.

Time: $O(b^m)$, but a good heuristic can give dramatic improvement

Space: $O(b^m)$ — keeps all nodes in memory

Optimal: No

A* search

Idea: avoid expanding paths that are already expensive

Evaluation function $f(n) = g(n) + h(n)$

$g(n)$ = cost so far to reach n

$h(n)$ = estimated cost to goal from n

$f(n)$ = estimated total cost of path through n to goal

A* search uses an *admissible* heuristic

i.e., $h(n) \leq h^*(n)$ where $h^*(n)$ is the *true* cost from n .

E.g., $h_{\text{SLD}}(n)$ never overestimates the actual road distance

Theorem: A* search is optimal

A* search example

Arad
366

A* search example [2]

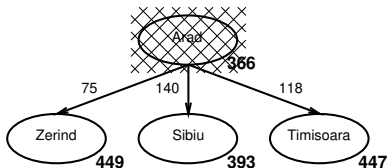

A* search example [3]

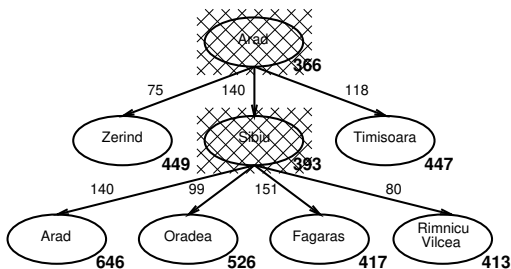

A* search example [4]

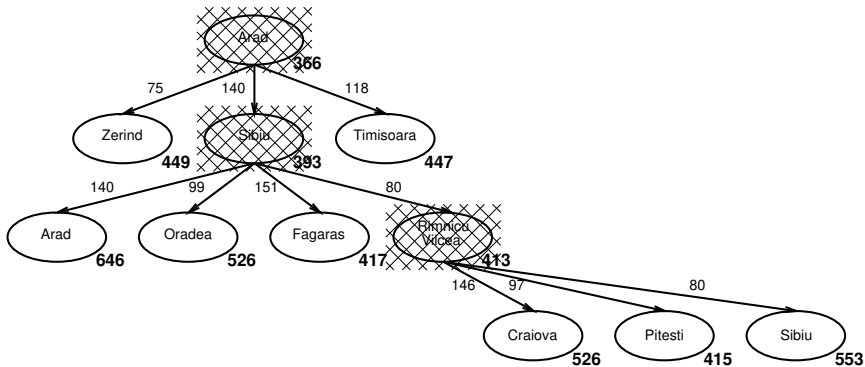

A* search example [5]

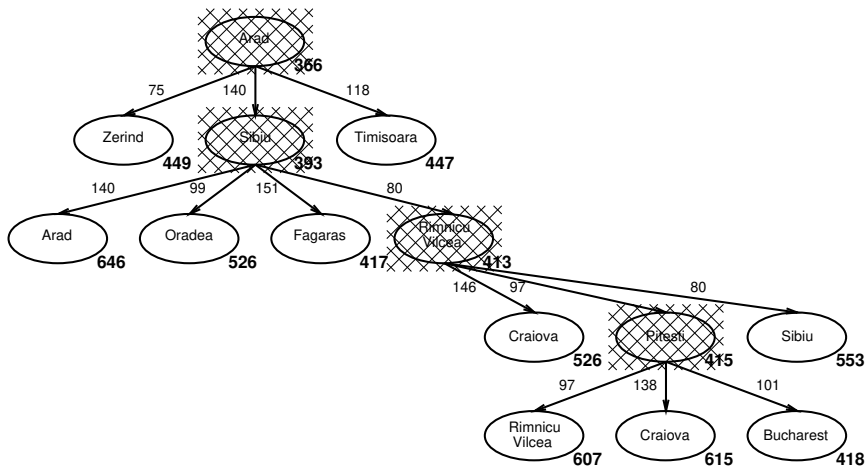

Problem Definition

Uninformed search strategies

Informed Search

Organizational

A* search example [6]

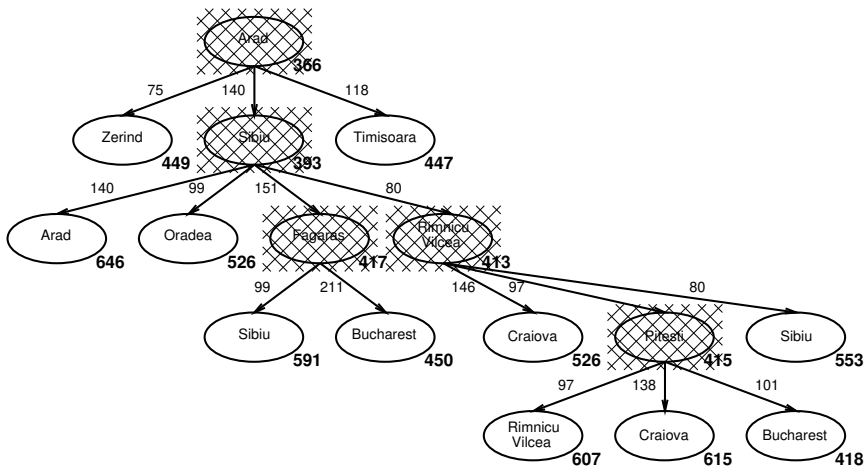

Problem Definition

Uninformed search strategies

Informed Search

Organizational

Optimality of A^* (standard proof)

Suppose some suboptimal goal G_2 has been generated and is in the queue. Let n be an unexpanded node on a shortest path to an optimal goal G_1 .

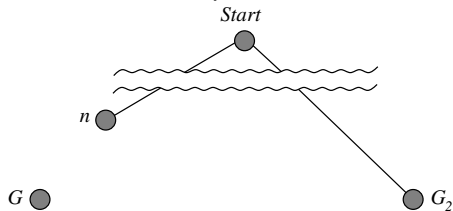

$$\begin{aligned}
 f(G_2) &= g(G_2) && \text{since } h(G_2) = 0 \\
 &> g(G_1) && \text{since } G_2 \text{ is suboptimal} \\
 &\geq f(n) && \text{since } h \text{ is admissible}
 \end{aligned}$$

Since $f(G_2) > f(n)$, A^* will never select G_2 for expansion

Optimality of A* (more useful)

Lemma: A* expands nodes in order of increasing f value

Gradually adds " f -contours" of nodes (cf. breadth-first adds layers)

Contour i has all nodes with $f = f_i$, where $f_i < f_{i+1}$

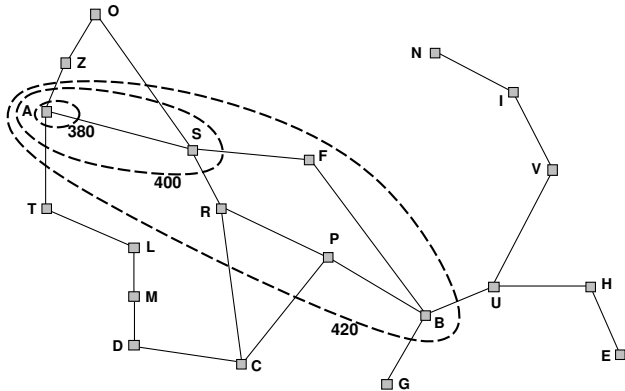

Problem Definition

Uninformed search strategies

Informed Search

Organizational

Properties of A*

Complete ?

Time ?

Space ?

Optimal ?

Properties of A^*

Complete: Yes, unless there are infinitely many nodes with $f \leq f(G)$

Time: Exponential in [relative error in $h \times$ length of soln.]

Space: Keeps all nodes in memory

Optimal: Yes — cannot expand f_{i+1} until f_i is finished

Admissible heuristics

E.g., for the 8-puzzle:

$h_1(n)$ = number of misplaced tiles

$h_2(n)$ = total **Manhattan** distance

(i.e., no. of squares from desired location of each tile)

5	4	
6	1	8
7	3	2

Start State

1	2	3
8		4
7	6	5

Goal State

$$h_1(S) = ?$$

$$h_2(S) = ?$$

Problem Definition

Uninformed search strategies

Informed Search

Organizational

Admissible heuristics

E.g., for the 8-puzzle:

$h_1(n)$ = number of misplaced tiles

$h_2(n)$ = total **Manhattan** distance

(i.e., no. of squares from desired location of each tile)

5	4	
6	1	8
7	3	2

Start State

1	2	3
8		4
7	6	5

Goal State

$$h_1(S) = 7$$

$$h_2(S) = 2+3+3+2+4+2+0+2 = 18$$

Dominance

If $h_2(n) \geq h_1(n)$ for all n (both admissible)
then h_2 dominates h_1 and is better for search

Typical search costs:

$d = 14$ IDS = 3,473,941 nodes

$A^*(h_1) = 539$ nodes

$A^*(h_2) = 113$ nodes

$d = 24$ IDS = too many nodes

$A^*(h_1) = 39,135$ nodes

$A^*(h_2) = 1,641$ nodes

(IDS = Iterative deepening search)

Relaxed problems

Admissible heuristics can be derived from the *exact* solution cost of a *relaxed* version of the problem

If the rules of the 8-puzzle are relaxed so that a tile can move *anywhere*, then $h_1(n)$ gives the shortest solution

If the rules are relaxed so that a tile can move to *any adjacent square*, then $h_2(n)$ gives the shortest solution

Key point: the optimal solution cost of a relaxed problem is no greater than the optimal solution cost of the real problem

Example: Travelling Salesperson Problem

Find the shortest tour that visits each city exactly once

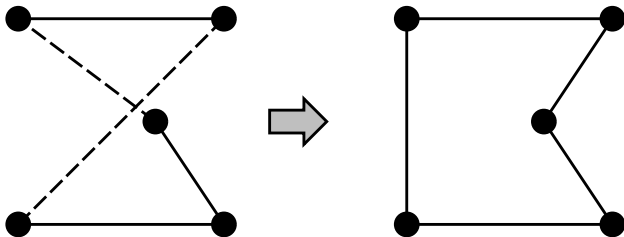

Minimum spanning tree heuristic can be computed in $O(n^2)$ and is a lower bound on the shortest (open) tour.

Example: n -queens

Put n queens on an $n \times n$ board with no two queens on the same row, column, or diagonal

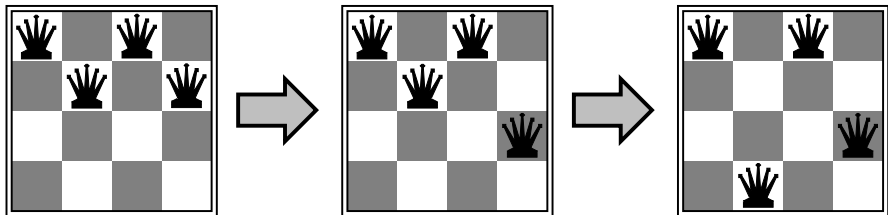

Problem Definition

Uninformed search strategies

Informed Search

Organizational

Hill-climbing (or gradient ascent/descent)

“Like climbing Everest in thick fog with amnesia”

```
function Hill-Climbing(problem) returns a solution state
  inputs: problem, a problem
  local variables: current, a node
                    next, a node

  current ← Make-Node(Initial-State[problem])
  loop do
    next ← a highest-valued successor of current
    if Value[next] < Value[current] then return current
    current ← next
  end
```

Hill-climbing contd.

Problem: depending on initial state, can get stuck on local maxima

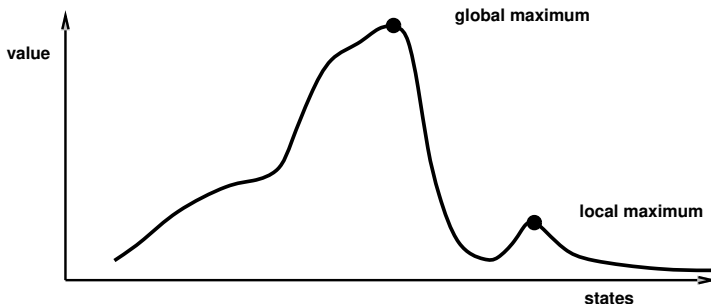

Simulated annealing

Idea: escape local maxima by allowing some “bad” moves
but gradually decrease their size and frequency

```
function Simulated-Annealing(problem, schedule) returns a solution state
  inputs: problem, a problem
            schedule, a mapping from time to “temperature”
  local variables: current, a node
                    next, a node
                    T, a “temperature” controlling the probability of downward
steps
```

```
current ← Make-Node(Initial-State[problem])
for t ← 1 to ∞ do
  T ← schedule[t]
  if T=0 then return current
  next ← a randomly selected successor of current
   $\Delta E$  ← Value[next] – Value[current]
  if  $\Delta E > 0$  then current ← next
  else current ← next only with probability  $e^{\Delta E/T}$ 
```

Problem Definition

Uninformed search strategies

Informed Search

Organizational

Properties of simulated annealing

At fixed “temperature” T , state occupation probability reaches Boltzman distribution:

$$p(x) = \alpha e^{-\frac{E(x)}{kT}}$$

T decreased slowly enough \implies always reach best state.

Is this necessarily an interesting guarantee?

Devised by Metropolis et al., 1953, for physical process modelling
Widely used in VLSI layout, airline scheduling, etc.

Contents

Problem Definition

Uninformed search strategies

BFS

Uniform-Cost

DFS

Depth-Limited

Iterative Deepening

Informed Search

Greedy

A*

Heuristics

Hill-climbing aka gradient ascent/descent

Simulated annealing

Organizational

Problem Definition

Uninformed search strategies

Informed Search

Organizational

Links

- MIT online course on AI (available for free):

<https://ocw.mit.edu/courses/electrical-engineering-and-computer-science/6-034-artificial-intelligence-spring-2005/>

- Original version of these slides used at Berkeley by Russel in his AI course, based on the AI book of Norvig and Russel:

<http://aima.eecs.berkeley.edu/slides-pdf/>

Info Summary

- Assignment 8 is optional, for extra points
- Assignment points: 9
- Assignment due: 21.12, Wednesday, 23:59 CEST
- Next class: 05.01.23, 14:15

Q & A

Thanks for your attention!